



K-PO Panther Instruction Manual



Downloaded
from
www.cbradio.nl

Thank you for choosing the K-PO Panther professional handheld CB radio. The K-PO Panther is an easy to use and handheld CB radio with an excellent performance. Please read this manual carefully before usage.

1. Control and functions buttons

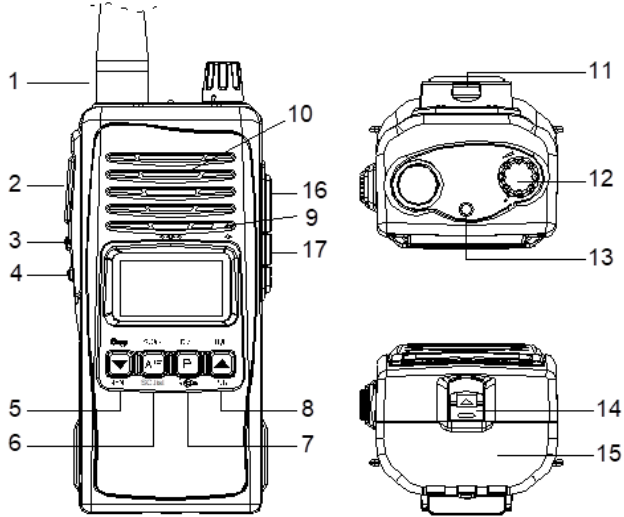

-
- 1) **Antenna:** TNC type connector.
 - 2) **PTT:** 'Push to Talk' button.
 - 3) **F:** Function button for activating multi-functions.
 - 4) **SQ:** Squelch on/off button.
 - 5) **Key lock / Down / MENU:** Key lock button, channel down button, enter 'MENU' when the 'F' button is held and pressed the same time.
 - 6) **SCAN / A/F / SC. List:** Scan function, AM/FM, enter 'Scan Channel List' when the 'F' button is held and pressed the same time.
 - 7) **DW / P / Lamp:** Dual Watch, priority (emergency) channel, LCD backlight on/off when the 'F' button is held and pressed the same time.
 - 8) **H/L / Up / RB:** High and low power switch, channel up button, Roger Beep on/off when the 'F' button is held and pressed the same time.
 - 9) **Internal Microphone**
 - 10) **Internal Speaker**
 - 11) **Belt Clip**
 - 12) **ON/OFF and Volume Knob:** To turn on the power of the radio and for adjusting the volume.
 - 13) **LED Indicator:** The LED indicator lights up red when transmitting and battery capacity (voltage) is low. The LED indicator lights up green when receiving or squelch is off.
 - 14) **Battery lock**
 - 15) **Battery pack**
 - 16) **External microphone jack**
 - 17) **External speaker jack**

2. Display icons

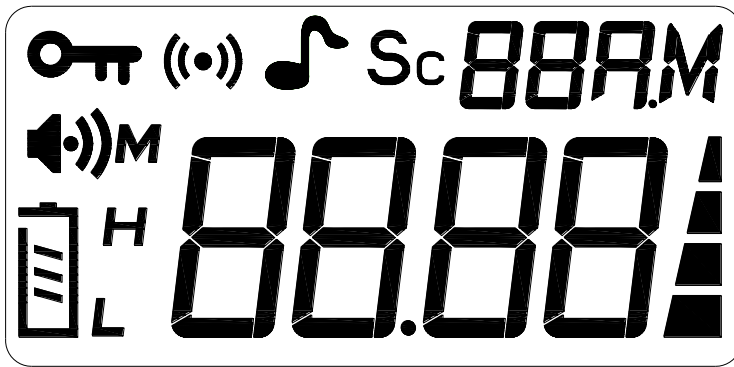

88.88

Channel (CH.01) or operating country band mode

88AM

Selected modulation AM / FM



Appears when the keypad is locked

Sc

Appears when a channel is stored in the scanning list



Appears when Roger Beep is on



Appears when Priority (Emergency) channel is on



Battery level, showing the battery capacity (voltage)

H

L

Transmitter output power (H = high, L = low)

M

Indicating the "MENU" function



Appears when a signal is received (RX)



Receiving signal level indicator and transmitting (TX) power indicator

3. Functions

3.1 Power ON/OFF and VOLUME control

Turn **[ON/OFF-Volume]** knob clockwise to switch on the radio and to increase the volume.

Every time the radio is switched on, the LCD will show the active band for 3 seconds.

Turn **[ON/OFF-Volume]** knob counter-clockwise to decrease the volume and to switch off the radio.

NOTE! When the radio is switched on, the display will show the battery voltage status during the start up.

3.2 Channel selection

Press the **[up]** or **[down]** button to decrease or increase the channel number.

3.3 Key lock

Press the **[down]** button for approximately 3 seconds to switch on/off the 'key lock'.

When the 'key lock' is switched on, the LCD display will show the  icon. All buttons will be deactivated, with exception of the **[PTT]** button.

3.4 Display backlight

Press and hold the **[F]** and **[P]** buttons simultaneously to switch on or off the 'display backlight'.

When the 'display backlight' is switched on the backlight will be lighted for 10 seconds every time a button is pressed, with exception of the **[PTT]** button and the volume knob.

3.5 Scan function

The 'scan function' scans channels that are listed in the 'scan channel list'. The listed channels will show the '**Sc**' icon on the display.

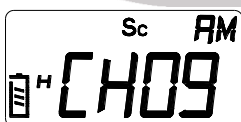

3.5.1 Adding a channel to the 'scanning list'

Select with the **[up]** or **[down]** button the channel that you want to add to the 'scanning list'.

Press and hold the **[F]** and **[A/F]** buttons simultaneously to add the chosen channel to the 'scanning list'. The channel in the list would have a **Sc** icon showing on the LCD display.

3.5.2 Deleting a channel from the scanning list

Select with the **[down]** or **[up]** button the channel that you want to delete from the 'scanning list'.

Press and hold the **[F]** and **[A/F]** buttons simultaneously to delete the channel from the 'scanning list'. The **Sc** icon will disappear.

3.5.3 Scan function ON/OFF

Press the **[A/F]** button for approximately 3 seconds to start the 'scan function'. The radio will start scanning the channels that are listed in the 'scanning list', the '**Sc**' icon will start blinking. The radio will scan 5 channels per second.

When a signal is received the radio will stop scanning and stays on the channel of reception. When the signal disappears it will continue to scan after 5 seconds, except when the **[PTT]** button is pressed or when the radio receives a signal again.

Press the **[A/F]** button for approximately 3 seconds to stop the 'scan function'. The radio will go back to the last used channel before scanning.

NOTE! When the **[P]** button is pressed it will stop scanning and go to the priority channel.

3.6 Priority (emergency) channel

Press the **[P]** button to go to the priority (emergency) channel 9 or 19 (depending on the selected country band mode). The display will show the  icon.

Press the **[P]** button again to quit the priority (emergency) channel and to go back to the last used channel. Or press the **[down]** or **[up]** button to leave the priority (emergency) channel and select a new channel.

NOTE! When operating in emergency channel, the scan function would be disable.

3.7 Monitor function

When squelch is on you can set the volume of the radio speaker as follow. Press and hold the **[SQ]** button. While holding the **[SQ]** button turn the **[volume knob]** of the radio to the desired volume strength. When you release the **[SQ]** button you have set the volume strength of the radio.

3.8 Transmitting (TX) and receiving (RX)



3.8.1 Transmitting mode (TX)

When the **[PTT]** button is pressed the radio will start transmit (TX) and the red LED will light up. The

LCD display will show the  icon.

3.8.2 Receiving mode (TX)

The green LED will light up when receiving a signal (RX) and is heard through the speaker. The

LCD display will show the  and  icons.

3.9 AM/FM selection

Depending on the selected country band mode the radio can operate in AM or FM.

Press the **[A/F]** button to choose "AM" or "FM". The display will show "AM" or "FM".

NOTE! In some country band modes, which are FM only, this function is not working.

3.10 Transmitting power

Press the **[up]** button for approximately 3 seconds to select the transmitting output power.

The display will show 'H' or 'L'.

FM: L (low) = 1W, H (high) = 4W

AM: L (low) = 1W, H (high) = 3W

3.11 Roger beep

The 'roger beep' function will give a beep tone when the **[PTT]** button is released.

Press and hold the **[F]** and **[up]** buttons simultaneously to activate the 'roger beep' tone. The LCD display will show the  icon.

Press and hold the **[F]** and **[up]** buttons simultaneously to de-activate the 'roger beep' tone. The  icon will disappear from the LCD display.

3.12 Dual watch

The 'dual watch' function will scan between the selected channel of operation and the priority (emergency) channel.

Press the **[P]** button for approximately 3 seconds to activate the 'dual watch' function. The LCD display will show the 'd' and  icons.



Press the **[P]** button for approximately 3 seconds to de-activate the 'dual watch' function. The 'd' and  icons will disappear from the LCD display.

NOTE! When a signal is received the radio will stop scanning and stays on the channel of reception. When the signal disappears it will continue to scan after 5 seconds, except when the **[PTT]** button is pressed or when the radio receives a signal again.

During 'dual watch' all buttons will be disabled, with exception of the **[PTT]**, **[SQ]** and **[P]** buttons.

3.13 Menu function

In the 'menu' you can change the 'squelch' level, 'battery power save' level and 'beep tone' settings. To enter the menu function press and hold the **[F]** and **[down]** buttons simultaneously. The LCD display will show the 'M' icon.

With the **[F]** button you can select the function that you want to change. With the **[down]** and **[up]** buttons you can change the settings of the selected function.

When you have changed the settings you can store the new settings by pressing the **[F]** button. It will go directly to the next setting. To go back to the operation mode press the **[PTT]** button.

3.13.1 Squelch level

When 'squelch' is selected in the 'menu' the LCD display will show 'SL' and the **59** icon is blinking.

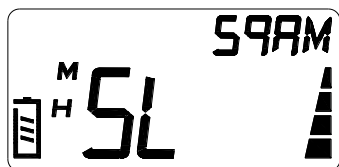

With the **[down]** and **[up]** buttons you can select the 'squelch' level. There are six squelch levels: off / 0-6. Press the **[F]** button to store the new settings and to go to the next function. To go back to the operation mode after storing the new settings press the **[PTT]** button.

3.13.2 Battery power save

When the 'battery power save' function is selected in the 'menu' the LCD display will show 'PS'.



With the **[down]** and **[up]** buttons you can select the 'battery power save' level. There are four battery power levels: off / 0-4. Press the **[F]** button to store the new settings and to go to the next function. To go back to the operation mode after storing the new settings press the **[PTT]** button.



3.13.2 Beep tone

When the 'beep tone' function is selected in the 'menu' the LCD display will show 'bP'. With the **[down]** and **[up]** buttons you can switch on or off the 'beep tone'.

bP.oF = beep tone is deactivated

bP.oN = beep tone is activated. You will now hear a beep tone when a button is pushed, with exception of the **[PTT]** and **[SQ]** buttons.

3.14 Battery indicator

The  icon in the LCD display shows the battery capacity level. When the battery capacity is low, the battery icon will be  and the red LED starts blinking.

NOTE! If the 'beep tone' is activated it will give a warning tone every 10 seconds when the battery voltage is low.

4. Band mode settings

Press and hold the **[F]** button and turn on the radio with the **[ON/OFF-Volume]** knob. The current country band mode starts blinking. Select with the **[down]** and **[up]** buttons the country band mode that is needed. When the correct country band mode is selected press the **[F]** button to confirm. Turn off and on the radio with the **[ON/OFF-Volume]** knob. Now the display shows the selected country band mode. There are 7 different country band modes (frequency bands):

	Channels	Frequency Range
EU	40 FM / 40 AM	26.965-27.405 MHz
EC	40 FM	26.965-27.405 MHz
d	40 FM / 40 AM	26.965-27.405 MHz
	80 FM	26.565-26.955 MHz
PL	40 FM / 40 AM	26.960-27.400 MHz
u	40 FM	27.60125-27.99125 MHz
IN	27 FM / 27 AM	26.965-27.275 MHz
IS	34 FM / 34 AM	26.965-26.865 MHz

5. Battery pack and charging

Put the battery pack on the back side of the radio (1-1). Now slide the battery till you will here a 'click' (1-2). The battery is now installed and locked.

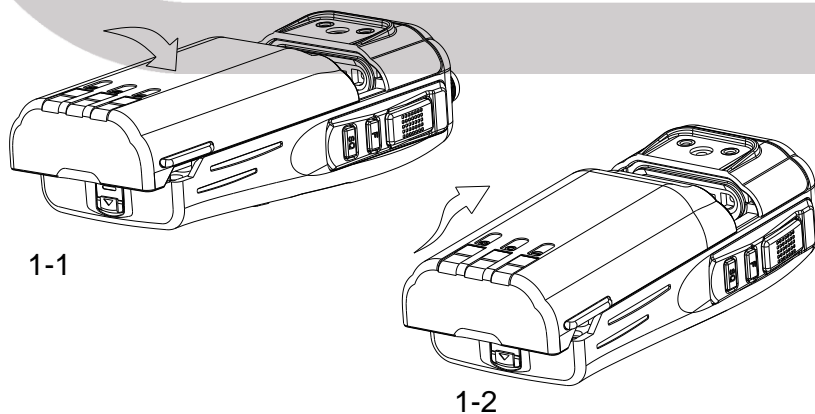

To remove the battery pull down the release latch on the bottom of the radio (2-1). Now slide battery down (2-2). The battery is now unlocked and can be removed.

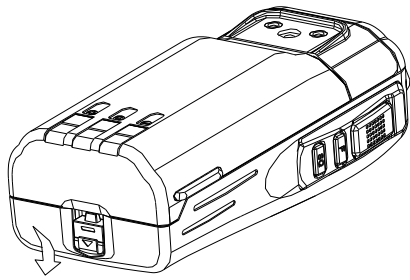

2-1

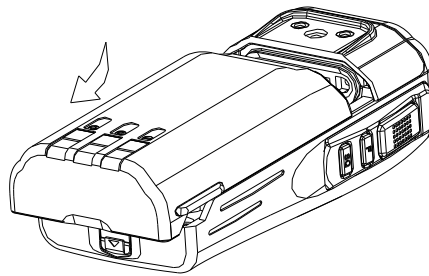

2-2

NOTE! First charge the battery pack before using. The charging time of the battery pack is around 12 hours. To charge the battery pack insert the charging plug of the supplied 230 volt wall charger into the charging jack on the backside of the battery pack. During charging the LED is continuously red. When the battery pack is fully charged the LED will lights up green. Now remove the charger from the radio and the 230 volt main socket.

6. K-PO Panther specifications

K-PO[®]

General	
Frequency range	26 - 28MHz.
Frequency control	Phase Lock Loop (PLL) synthesizer
Channel spacing	10KHz
Modulation mode	AM/FM
Frequency stability	± 0.005 %
Channel step	10KHz
Maximum channel	> 40 channel
Operating temperature range	-25°C to +50°C
Input voltage	7.4VDC
Working voltage	6.8~8.4V
Antenna connector	TNC with 50 ohms
Dimensions	120(H) x 54(W) x 35(D) mm
Weight	About 250 gram (including battery)
Transmitter	
AM /FM power output	FM: 1/4W AM: Carry power 1/3W with 50% modulation
Spurious emissions	-55 dB.
Carrier suppression	-55 dB.
Audio frequency response	300Hz to 2.5KHz
Max. modulation FM	+/- 2KHz
AM	100%
Receiver	
AM sensitivity for 10dB S/N	< 1.0 µV.
FM sensitivity for 12dB S/N	< 0.2 µV.
Image rejection ratio	> -65 dB.
Adjacent channel selectivity	> -55 dB.
Squelch adjustable;	6 Levels
Audio output power	> 0.5W
Signal to noise ratio	> 40db
Internal speaker	8 Ohms; 1 Watts.



KBC import / export
Argonstraat 6
6718 WT Ede
The Netherlands
www.k-po.com